

## 4.12. Remote control installation

The remote-control panel is designed to be mounted in a dry indoor area by fixing it to the wall. It cannot be used in areas where water vapor condensation is present.

The installation of the control panel must be carried out following the instructions provided below.

Remove the mounting frame from the back panel of the housing. To remove the frame, use a flat screwdriver. The cable connecting the panel to the controller must be routed into the wall. The cable cannot be laid together with the building's electrical network cables. The cable must not run alongside devices emitting strong electromagnetic fields.

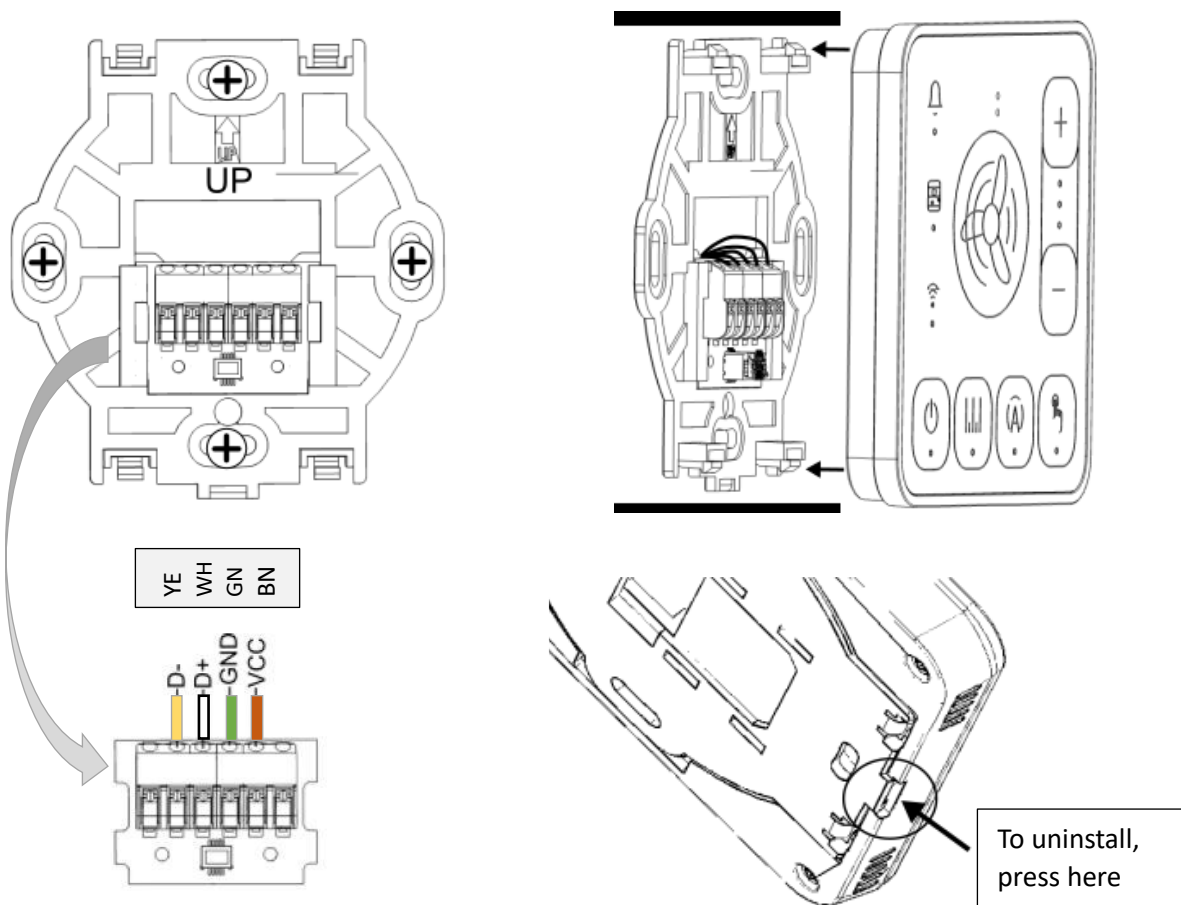

After the unit is connected to the power supply, LED diodes



will start blinking sequentially, indicating that the controller's software is being loaded. Loading takes about 10 seconds. If this time is much longer, check the correctness of the D + and D- wires of the transmission cable connecting the panel with the controller.

#### 4.11. Electrical wiring diagram

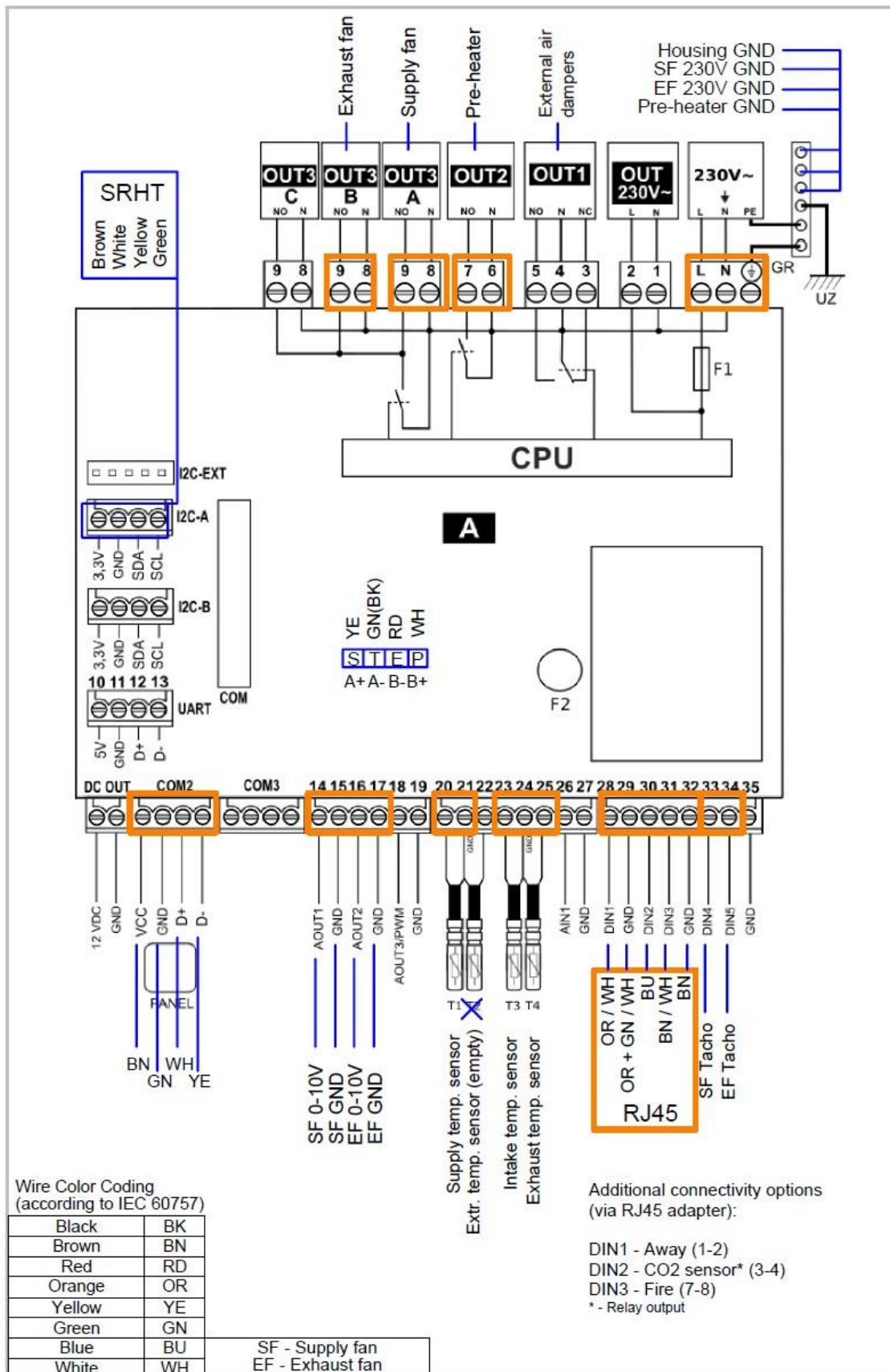

**Resistance input (NTC 10 K):**

- T1** – supply temperature sensor - before the secondary exchanger (required);
- T2** – extraction temperature sensor (required) or air intake sensor on the building facade;
- T3** – intake temperature sensor - at the filters (required);
- T4** – exhaust temperature sensor (required);

**Analog output (0-10 VDC):**

- AOUT1** – supply air fan;
- AOUT2** – exhaust air fan;

**Analog output (0-10 VDC or PWM):**

- AOUT3 / PWM** – control of the primary heater via solid state relay (SSR);

**Analog input (0 - 10 VDC):**

- AIN1** – analog humidity sensor;

**Digital input (additional device connection):**

- DIN1** – “Away” function (NC contact);
- DIN2** – for an external CO2 sensor (NC contact);
- DIN3** – for fire alarm;

**Voltage output:**

- OUT 230 V ~** - non-controllable mains voltage output to power the eV-Ex04 module;
- DC OUT** - 24 VDC non-controlled voltage output;

**Relay output (potential):**

- OUT1** – change of the direction of rotation of the exchanger actuator;
- OUT2** – pre-heater;
- OUT3A... OUT3C** – supply and exhaust air fans and ionizer

**Data transmission bus:**

- RJ** - ecoNET300 internet module;
- COM** - eV-Ex04 expansion module;
- UART** - RS232 transmission - empty;
- COM2** – remote control panel (12 VDC supply voltage);
- COM** – socket for connecting expansion module B;
- I2C-A** – socket for differential pressure sensor SRHT IN1 or air quality sensor SCO2 IN1, or humidity sensor SRHT IN1;
- I2C-B** - socket for differential pressure sensor SRHT IN1 or air quality sensor SCO2 IN1, or humidity sensor SRHT IN1;
- I2C-EXT** – I2C transmission, in parallel with I2C-A and I2C-B;
- CPU** - controller;
- L, N, PE** - 230 V ~ controller power supply;
- F1** – main line fuse T6.3 A / 250 VAC;
- F2** - TR5 mains fuse, 630 mA / 250 VAC;
- UZ** - grounding;

### 4.13. Additional device connection (comfort connector)

The installer can choose several auxiliary devices to expand the capabilities of the unit. By shorting the corresponding RJ45 connector contacts, the functions listed below can be activated.

Table 4

Contact No.	Activated function	Meaning
1 - 2	Away	Reducing ventilation power when leaving the house. Activation can be done with a key light switch or by activating a security alarm.
3 - 4	CO <sub>2</sub> sensor	Increase in ventilation capacity based on readings from connected additional CO <sub>2</sub> or humidity sensors.
7 - 8	Fire alarm	Emergency shutdown of the unit in the event of a fire alarm.

An additional RJ45 adapter should be used for more convenient connection:

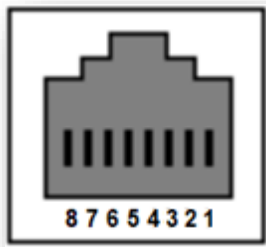

	To activate the function, only a passive electrical switch or relay output should be used.	
	Devices for activating functions	
Keypad light activation switch for "Away" function		Duct CO <sub>2</sub> sensor with relay output. Recommended model: DXC-G.

## 5. DEVICE INITIALIZATION, INSPECTION, AND OPERATION



Before turning the device on, check the inside for any foreign objects, rubbish, or tools. Make sure that the unit has an air filter, the condensate drainage (if required) is connected, and the siphon is filled with water. Inspect the air duct system to ensure there are no obstructions, such as fully closed diffusers or control valves, and make sure the outdoor supply air grilles are not blocked.

The ventilation unit may come with one of two control panels:

- 1) Wired **Easy** control panel with touch-sensitive buttons that can be used only for basic ventilation modes and settings.
- 2) Wired **LCD SimpleTouch** control panel with a touch-sensitive color display, where many of the unit's functions and settings can be viewed and changed.

The unit can be controlled in the following ways:

- 1) Wired remote control **Easy** or **LCD SimpleTouch** control panel,
- 2) smartphone via **OXYGEN Installer** app (Bluetooth) or the **OXYGEN easy** app (Wi-Fi connection).
- 3) Computer via [easy.oxygenvent.com](http://easy.oxygenvent.com) website.

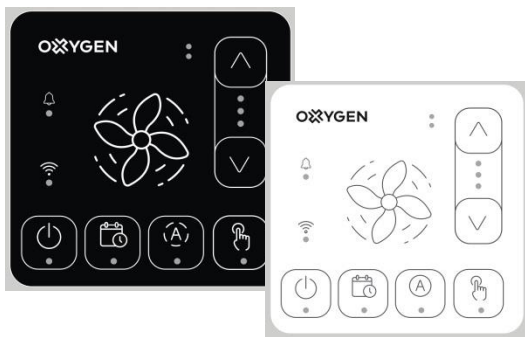

Easy control panel



LCD SimpleTouch control panel



OXYGEN Easy cloud

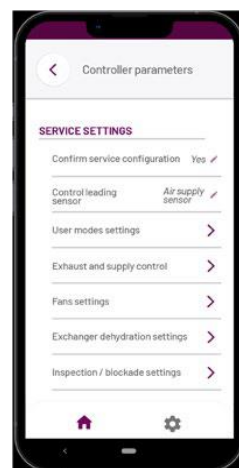

OXYGEN Installer app

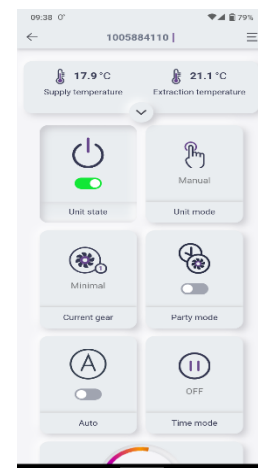



OXYGEN easy app

## 5.1. Operating via the control panel

The Easy control panel can only control basic ventilation modes and settings.

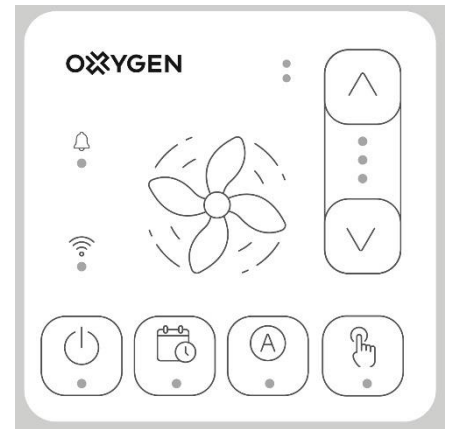
The device is controlled by touching the selected function button on the Easy control panel. Button symbols and LED signal meanings:



 - an LED that lights up means the device is switched on. Other LEDs, also indicate the status of the unit when it is switched on, e.g. fan speed selected, automatic control activated, scheduling, manual control.

 - An LED illuminates to inform you when the unit is operating according to the timetable set by the weekly operating modes. If the time schedule is not set or not activated, the LED flashes. When the weekly operating mode is activated, the LED for the manual control switches off and vice versa.

 - The speed of the recuperator fans will change automatically depending on the air quality information received from the CO2 sensor (if fitted).

 - the recuperator operates in manual mode, which allows you to set the desired fan speed.



 - increasing or decreasing the fan speed. This function only works when the manual control is activated.

 - signaling of active events from the unit.

-  - A rapidly flashing symbol means that a Bluetooth signal is being emitted.
- A steady lit symbol means there is an active connection to the Wi-Fi network and the internet.
- A slow flashing symbol means there is a connection to a Wi-Fi network but no internet connection.

When the unit is plugged into the main power supply, for the first 40 seconds after switch-on, the unit automation will evaluate the factory settings, check the automation components, open the external air dampers (in case of a ductwork system with actuated dampers) and set the By-pass damper to its initial position. A low humming noise will be heard during the bypass damper setting. This is normal unit operation.

A rapidly flashing symbol  means that a BT signal is being emitted.

When the By-pass damper stepper motor stops running, switch the unit on by pressing the button marked with the symbol . The LED on this button will briefly illuminate, followed by the manual mode LED .

When the button marked with  is touched, the first LED will light up, and after 20 seconds, the fans will start operating.

Later, after turning off the device from the power supply and turning it on again, the device will start operating in the last set ventilation mode.

## 5.2. Controlling the device via "OXYGEN Installer" app (Bluetooth connection)

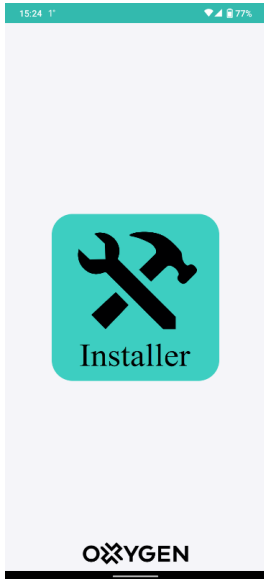

**OXYGEN Installer** app is designed for device control and configuration via Bluetooth when there is no Wi-Fi connection. Note: effective Bluetooth (BT) range is about 10 meters, so if you are in a different room from the device, your smartphone may not detect the device.

To control the device via Bluetooth, you need to install the **OXYGEN Installer** app on your smartphone or tablet. You can download it for free from Google Play (for Android devices from version 8 onwards) or the App Store, using the QR code or link provided on the manufacturer's website below.



Google Play



App Store

Android: <https://play.google.com/store/apps/details?id=com.oxygen.lt.oxygeninstaller>

iOS: <https://apps.apple.com/be/developer/oxygen-group-uab/id1522780335>

After installing the app, open it and initiate the search. The device must be connected to the network, and Bluetooth connection must be active (rapidly blinking BT symbol on the control panel). In the popup window "**Device choice**", select "**Internet gateway**", then proceed to "**Internet gateway settings**" > "**Time synchronization with phone**". The controller will automatically synchronize the date and time with your phone's clock.

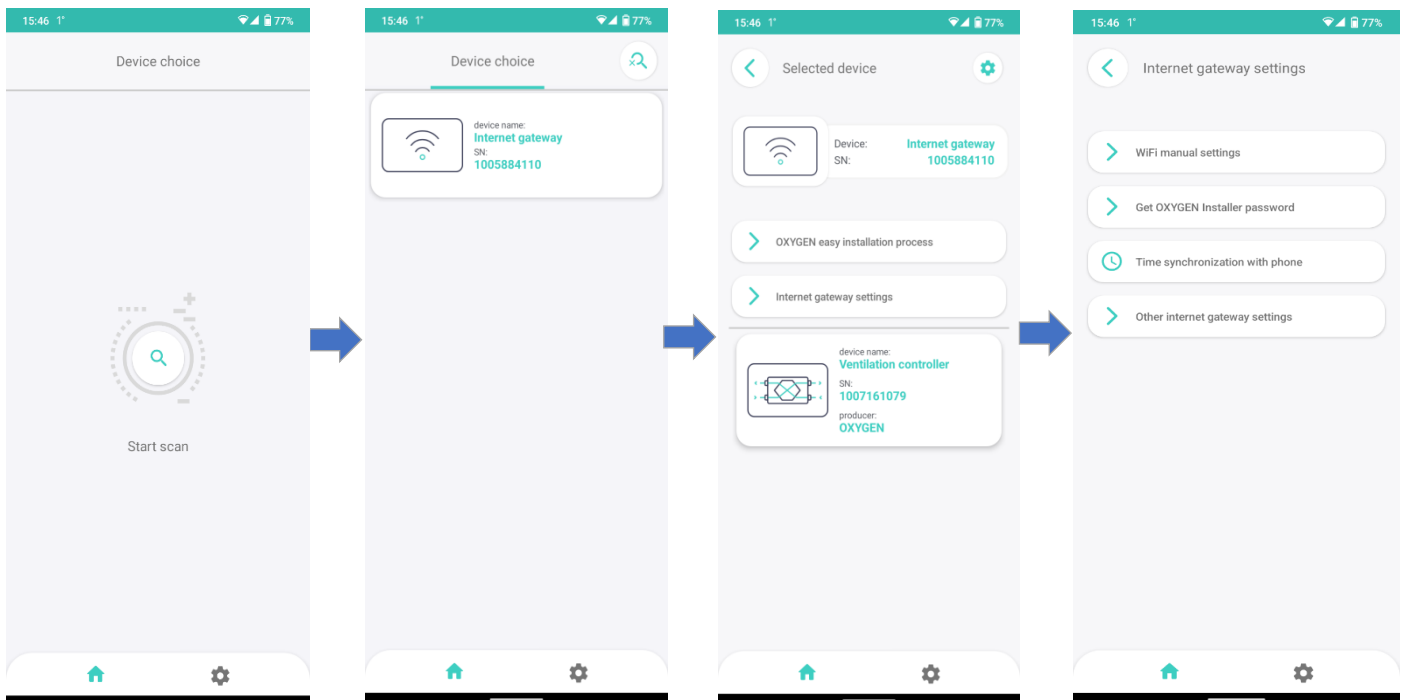

Then return to the "Select device" window and choose "Ventilator controller" (highlighted in red). In this window, you can access one of the three suggested menus: 1) User settings, 2) Service settings, and 3) Creating weekly schedules (Schedule).

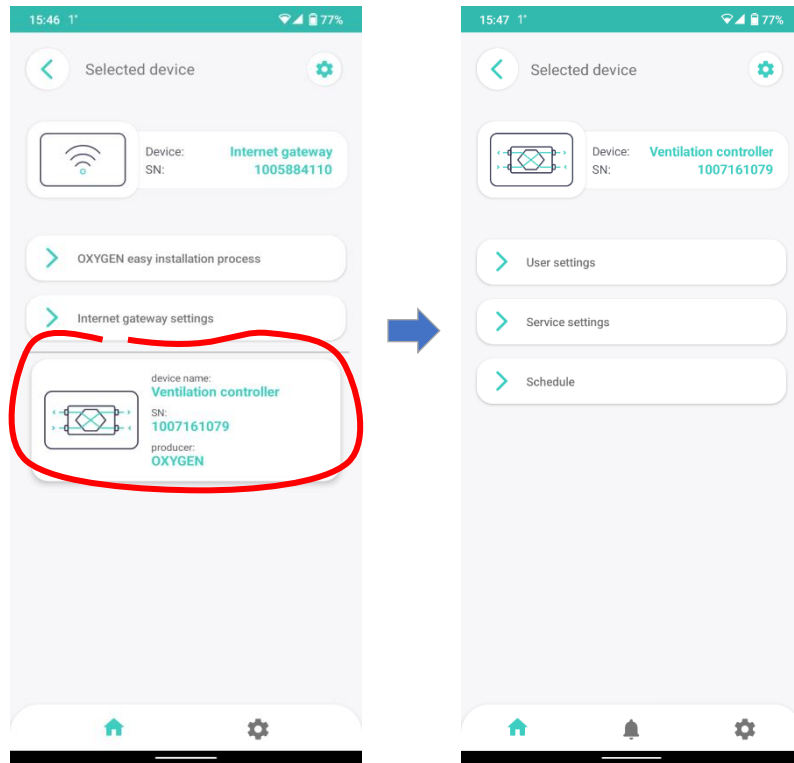



### 5.2.1. User settings

The table below shows the values of the user settings. Once you have selected the desired value, you need to touch the "Accept" button for it to be executed.

Table 5

<b>Work modes</b>		
<b>Unit state</b>	<b>ON</b>	Turn on the device
	<b>OFF</b>	Turn off the device
<b>Unit mode</b>	<b>Manual</b>	The device will operate in manual mode
	<b>Schedule</b>	The device will work according to the weekly schedule set by the device user
<b>Current gear</b>	<b>Minimal</b>	The fans will run at the speeds set by the user of the unit. Factory settings are: minimum - 30%, normal - 50%, intense - 75%.
	<b>Normal</b>	
	<b>Intensive</b>	
	<b>Pause</b>	Suspension of the installation
<b>Auto</b>	<b>On</b>	The device works on the basis of information from an external CO2 sensor.
	<b>Off</b>	
<b>Time mode</b>	<b>Out</b>	This function can be selected when you leave home. The device will be switched off for a set period of time.
	<b>Party</b>	Increases air circulation in rooms for a set period of time. Useful when more people are gathered indoors
	<b>Airing</b>	When this function is activated, the air supply fan stops. The function can be adapted to quickly ventilate the room, e.g. in the kitchen when food is too hot.
	<b>Off</b>	Turn off activated "Time mode"
<b>Schedules</b>	<b>Yes</b>	Switching the weekly timetable On/Off
	<b>No</b>	
<b>Fireplace</b>	<b>Yes</b>	The fireplace mode brings more fresh air into the room (causing overpressure) and thus improves smoke extraction through the chimney. Only switch on when the fireplace is in use. Factory setting - (-20%)
	<b>No</b>	
<b>Fan speed difference – fireplace</b>	<b>Yes</b>	Percentage difference between supply and extract air fan flows
	<b>No</b>	
<b>Temperature of comfort</b>	<b>Comfort temperature of Gear 1</b>	The function only operates in the summer when the outdoor temperature is lower than the set threshold. The function is chosen to cool down the rooms with cooler outdoor air.
	<b>Comfort temperature of Gear 2</b>	
	<b>Comfort temperature of Gear 3</b>	
<b>User modes</b>		
<b>Minimal</b>	<b>Supply fan control</b>	The user can choose the airflow rate for each fan speed individually. We recommend that the supply and extract air fans run at the same speed, otherwise the system may be unbalanced.  Recommended rates: 1st speed (minimum) 25 - 45% 2nd speed (normal) 45 - 70%
	<b>Extraction fan control</b>	
<b>Normal</b>	<b>Supply fan control</b>	
	<b>Extraction fan control</b>	
<b>Intensive</b>	<b>Supply fan control</b>	
	<b>Extraction fan control</b>	

		3rd speed (intensive) 70 - 100%
<b>Time modes settings</b>		
<b>Airing</b>	<b>Set fan control</b>	The function is designed to quickly ventilate rooms, for example when food is burnt, and unpleasant odors are spread throughout the room. When activated, this function stops the supply air fan, so that the window(s) must be opened to allow air to flow freely to prevent a vacuum from forming. The function is more suitable for the warmer seasons.
	<b>Airing mode time duration</b>	
<b>Party</b>	<b>Temperature of comfort</b>	The function is designed to speed up air circulation when large numbers of people gather indoors. The fans will run at 90% speed for a set period of time.
	<b>Party mode duration</b>	
<b>Out</b>	<b>Exit mode time duration</b>	A feature to turn off the device for a set period of time when you leave the house.
<b>Information</b>		
<b>Current work status</b>		
<b>Current comfort temperature</b>	Displays the comfort temperature set by the user.	
<b>Current lead temperature</b>		
<b>Control mode</b>	<b>Heating</b>	
<b>Outdoor temperature</b>		
<b>Work mode</b>	<b>Auto</b>	
<b>Current work mode</b>		
<b>Main work mode</b>	<b>Minimal</b>	
<b>Temporary work mode</b>	<b>OFF / ON</b>	
<b>Schedule</b>	<b>Inactive / Active</b>	
<b>Temperatures</b>		
<b>Intake air temperature (1)</b>	°C	
<b>Exhaust air temperature</b>	°C	
<b>Supply air temperature</b>	°C	
<b>Extract air temperature</b>	°C	
<b>Additional sensor temperature (if installed)</b>	°C	
<b>Fans control</b>		
<b>Control mode</b>	<b>Standard</b>	
<b>Supply fan – work state</b>	<b>ON / OFF</b>	
<b>Supply fan - control</b>	%	
<b>Extraction fan – work state</b>	<b>ON / OFF</b>	
<b>Extraction fan - control</b>	%	
<b>Supply fan – revolutions per minute</b>	RPM	
<b>Extraction fan – revolutions per minute</b>	RPM	
<b>Filters</b>		
<b>Change - supply air filter</b>	<b>No / Yes</b>	
<b>Change - extraction air filter</b>	<b>No / Yes</b>	
<b>Filters - information</b>		
<b>Supply air filter – expire state</b>	<b>15%</b> <i>(85% remain valid)</i>	
<b>Extract air filter – expire state</b>	<b>15%</b>	

		<i>(85% remain valid)</i>
<b>Operation days - supply filter</b>		Shows how many days the filter has been used
<b>Operation days - extract filter</b>		Shows how many days the filter has been used
<b>Heat recovery</b>		
<b>Bypass control</b>		<i>0% - fully closed</i> <i>100% - fully open</i>
<b>Preheater</b>		
<b>Preheater type</b>		<i>Electric / 0 – 10VDC / PWM</i>
<b>Preheater state</b>		<i>ON / OFF</i>
<b>Air quality switch</b>		
<b>Humidity level exceeded</b>		<i>Yes / No</i>
<b>Analog air quality sensor</b>		
<b>Current humidity</b>		<i>%</i>
<b>Humidity set point</b>		<i>%</i>
<b>Humidity hysteresis</b>		<i>%</i>
<b>Operation hours</b>		
<b>Days of device operation</b>		
<b>Days until review</b>		
<b>Filters</b>		
<b>Start filter change procedure</b>	<b>No</b>	Before starting the filter change procedure, choose "Yes"
	<b>Yes</b>	
<b>Alarm control panel</b>		
<b>Alarm control panel enable</b>	<b>Yes</b>	The function is activated to enable the recuperator to respond to the activation of the alarm system.
	<b>No</b>	
<b>Input logic state</b>	<b>Normally closed</b>	The selection should be made based on the scheme of the alarm control panel.
	<b>Normally open</b>	
<b>Ventilation unit response</b>	<b>Switching off the panel</b>	When the "Alarm control panel enable" function is activated and the alarm is triggered, the device will shut down.
	<b>Change of speed</b>	When the "Alarm control panel enable" function is activated and the alarm is triggered, the fan will operate at a selected speed.
<b>Extraction fan control</b>	25% - 100%	When the "Alarm control panel enable" function is activated, "Change of speed" is selected, and the alarm is triggered, the fans will operate at a selected speed.
<b>Supply fan control</b>	25% - 100%	
<b>Airing</b>	<b>Inactive</b> <b>Active</b>	When the "Alarm control panel enable" function is activated and the alarm is triggered, you can select the ventilation function.
<b>Airing</b>		
<b>Supply fan control</b>	25% - 100%	When the "Alarm control panel enable" function is enabled and the "Airing" function is activated, upon triggering the alarm, the device will ventilate the premises according to the set parameters.
<b>Extraction fan control</b>	25% - 100%	
<b>Duration of airing</b>	1min. – 100min.	
<b>Airing time cycle</b>	1h – 24h	

- (1) – The temperature sensor is located behind the heating element, so during the cold season, when the heater is on, the displayed temperature will reflect the temperature of the air supplied to the heat exchanger.

### 5.3. Configuring your Wi-Fi connection

To control the device remotely via smartphone or through the **easy.oxygenvent.com** website, you will need to perform the steps listed below.



**The device must be turned off, but Bluetooth connectivity must be active, i.e., the BT symbol blinking rapidly.** The smartphone must have the **OXYGEN easy** app installed. It can be downloaded for free from

Google Play or the App Store:

Android: <https://play.google.com/store/apps/details?id=com.oxygenvent.easy>

iOS: <https://apps.apple.com/be/app/oxygen-easy/id6477522929>



#### 5.3.1. Create an account on the **easy.oxygenvent.com** website.

The password must consist of at least eight characters, including at least one number, one uppercase letter, one lowercase letter, and one special character.

After entering the required information, click on "Sign up". You should receive an email requesting confirmation of registration in your email inbox. If you don't see the message in your Inbox folder, please check your Junk or Spam folder and make sure to move the email to the Inbox directory.

5.3.2. Open the installed app and select the "ADD" button. In the opened "Add new installation" window, select the BT button, and then follow the app's suggested prompts.

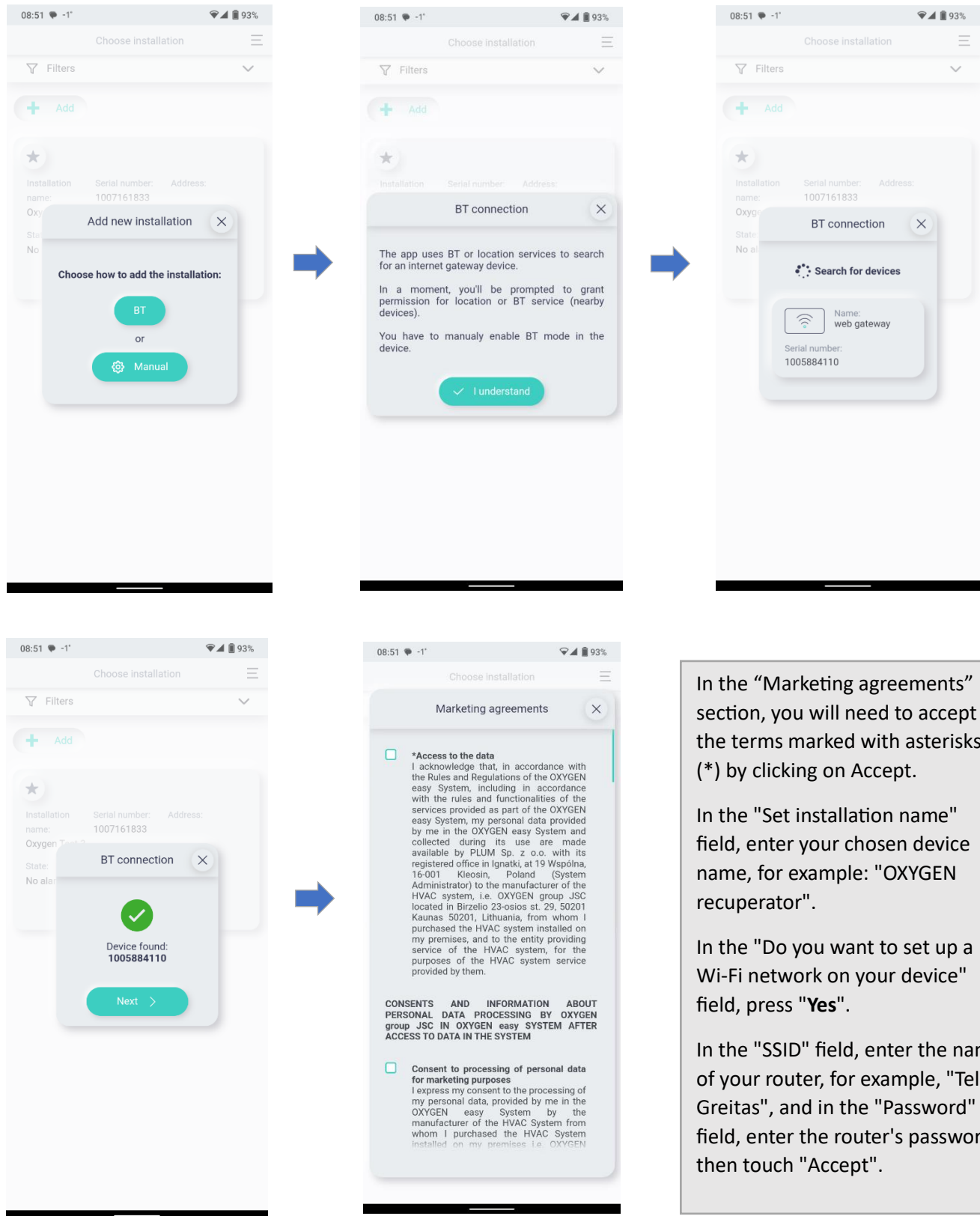



In the "Marketing agreements" section, you will need to accept all the terms marked with asterisks (\*) by clicking on Accept.

In the "Set installation name" field, enter your chosen device name, for example: "OXYGEN recuperator".

In the "Do you want to set up a Wi-Fi network on your device" field, press "Yes".

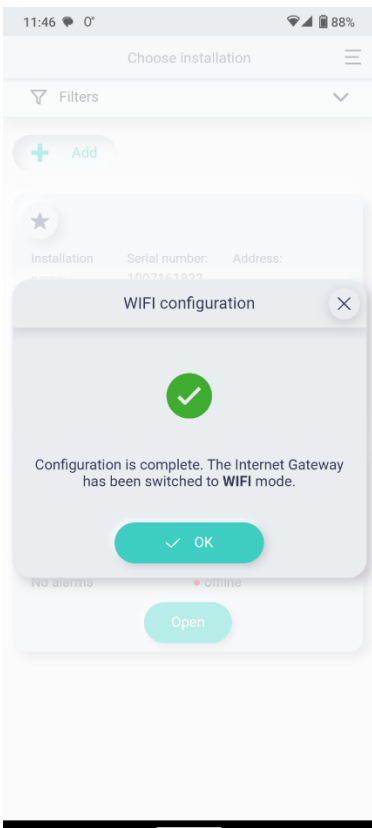
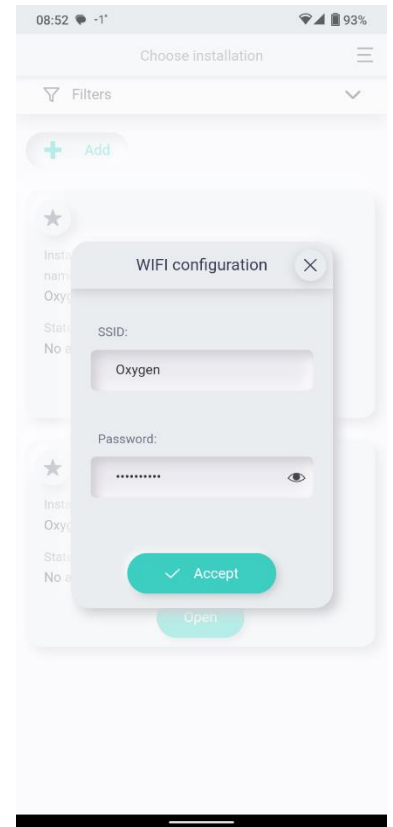
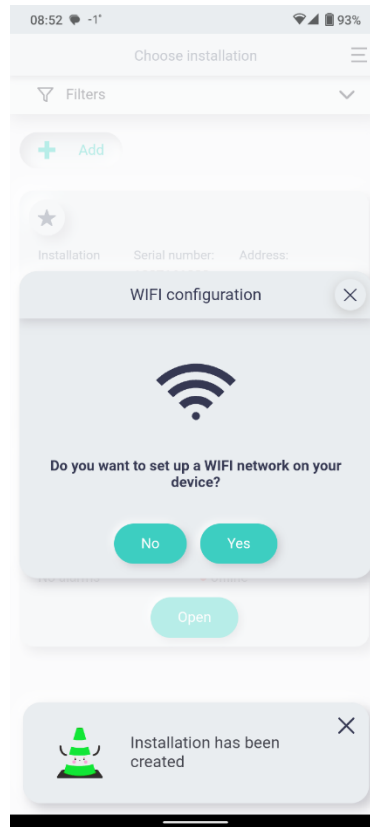
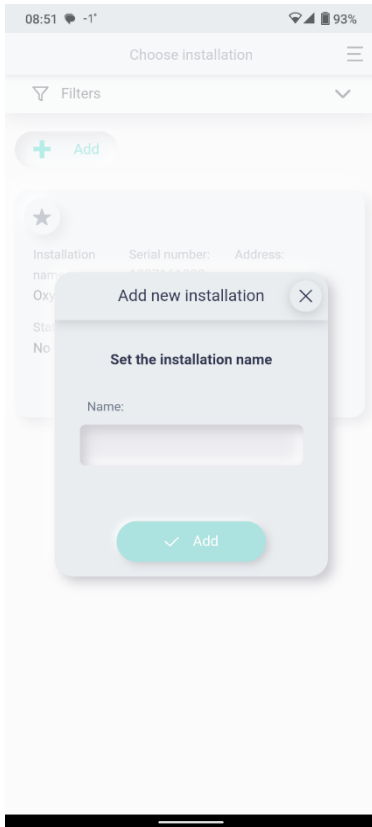
In the "SSID" field, enter the name of your router, for example, "Telia Greitas", and in the "Password" field, enter the router's password, then touch "Accept".



Upon opening the "WI-FI configuration" window, you should wait for the controller to reboot – on the Easy control panel, the LED  blinking will stop, and the symbol will change from rapidly blinking to constantly lit. This indicates that the controller has switched from Bluetooth to Wi-Fi connection. Now, you can remotely control the device with your smartphone through the **OXYGEN easy** app or by accessing the **easy.oxygenvent.com** website from your computer.

In the "Choose installation" window that opens, select "**Open**", and in the following window, select the "+" symbol.

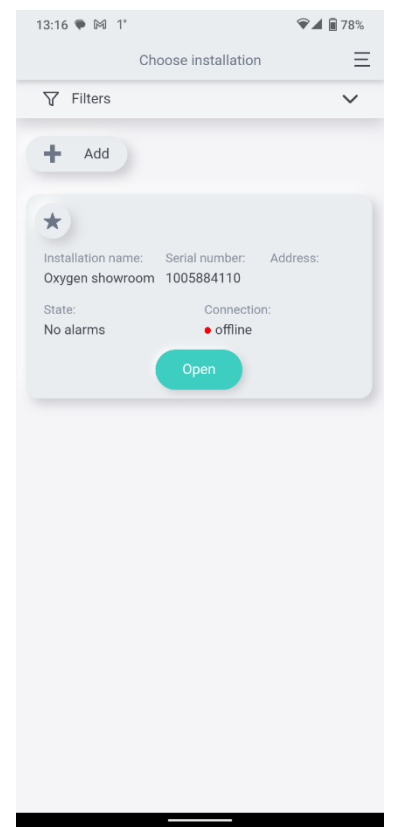

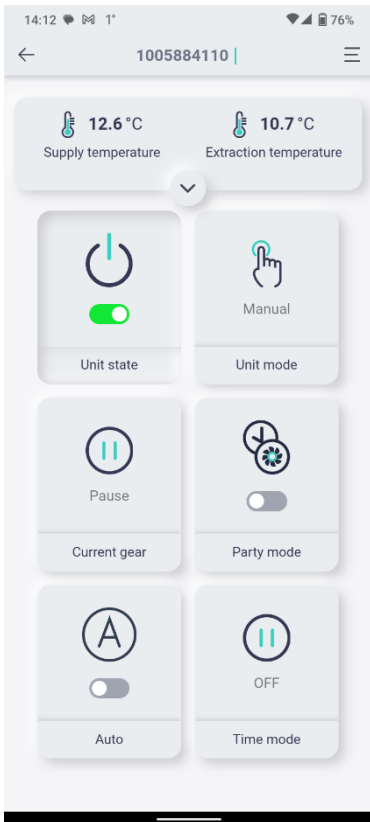
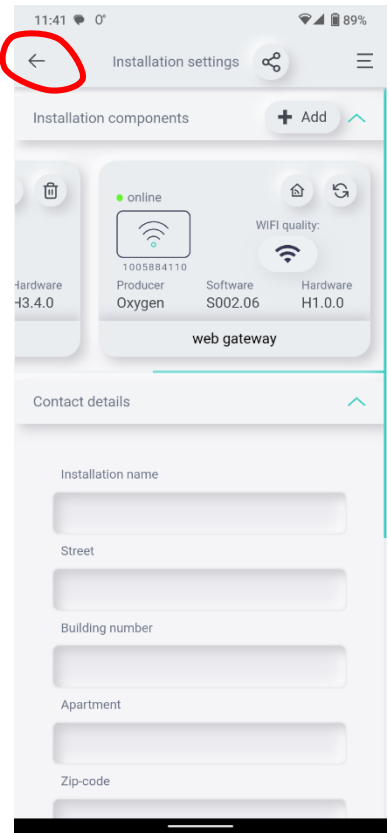
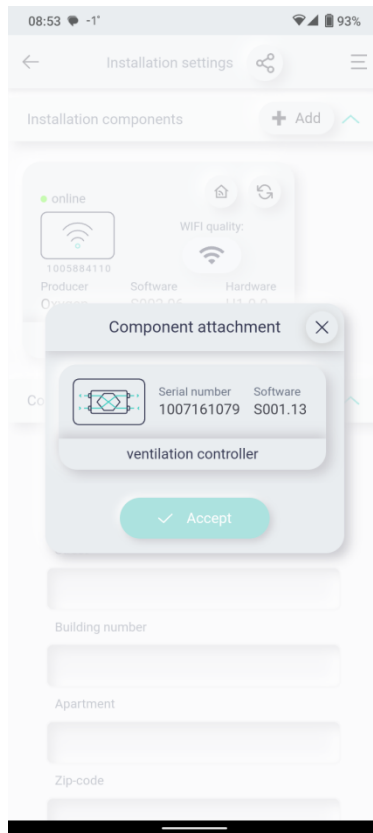
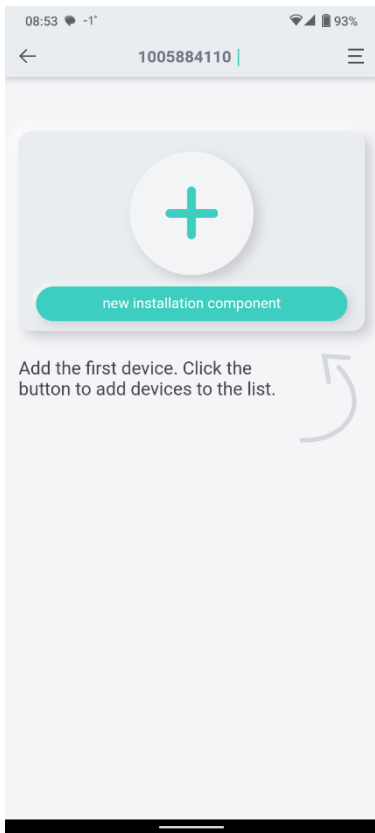

**OXYGEN easy** app window on your smartphone.

Here you will see the quick access buttons to control the device. Advanced management and information about the device can be accessed via the menu on the top right-hand side.

The values of the buttons are listed in Table 5.



## 5.4. Controlling the device via [easy.oxygenvent.com](https://easy.oxygenvent.com) website

Open the [easy.oxygenvent.com](https://easy.oxygenvent.com) website window. If you have a WI-FI connection, the green online dot will light up.

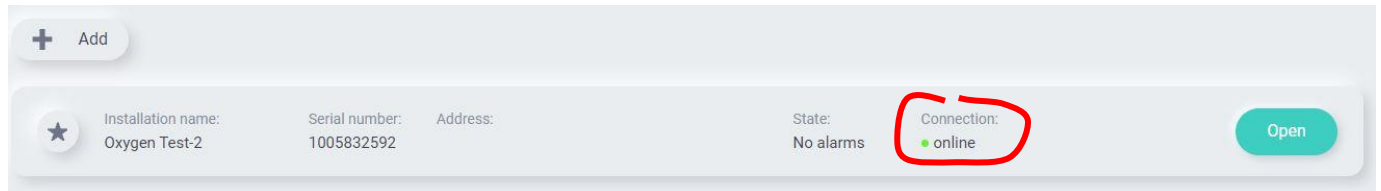

### 5.4.1. "Home" window

The top line displays only basic information, i.e. supply and extract air temperatures, filter contamination, relative humidity of the extract air, fan speed and the status of the By-pass damper (0% means closed).

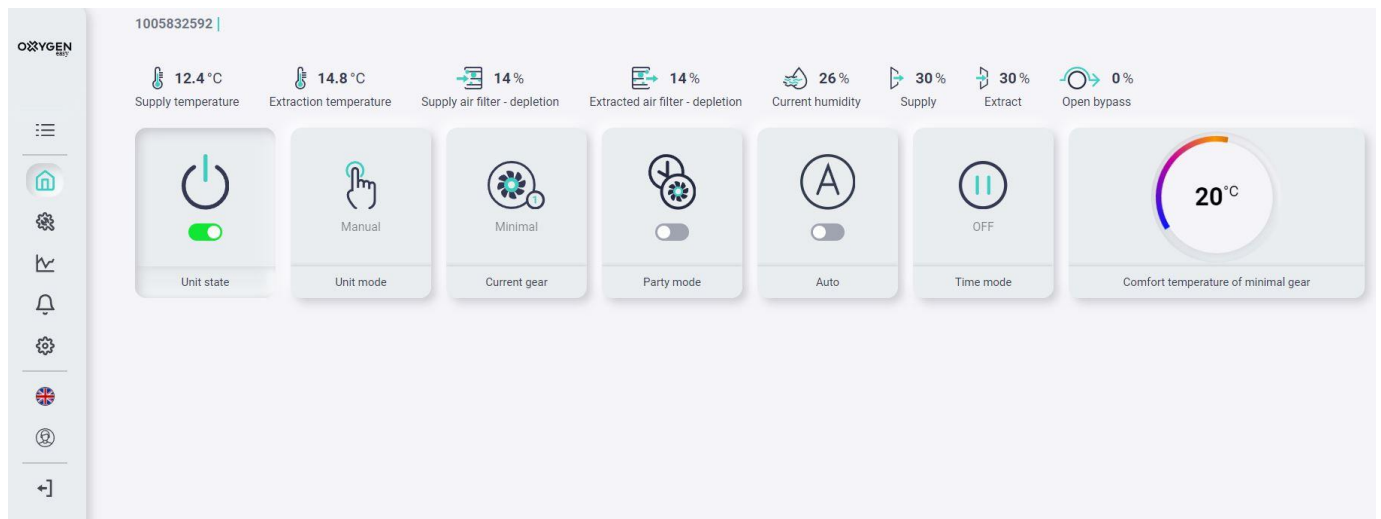

The buttons on the second row are used to control the device:

**Unit state** -Switching the device on/off

**Unit mode - Manual** – the device will operate in manual mode.

**Unit mode - Schedule** – The unit will work according to the weekly programme that is set up.

To schedule a weekly programme, press the Schedule button. In the window that opens, an additional box "Schedule" will appear on the right hand side (photo below).

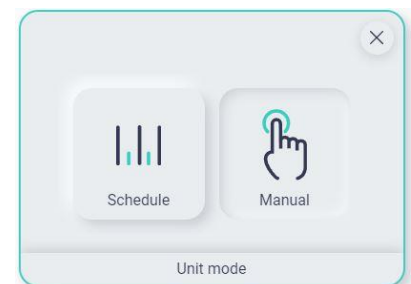

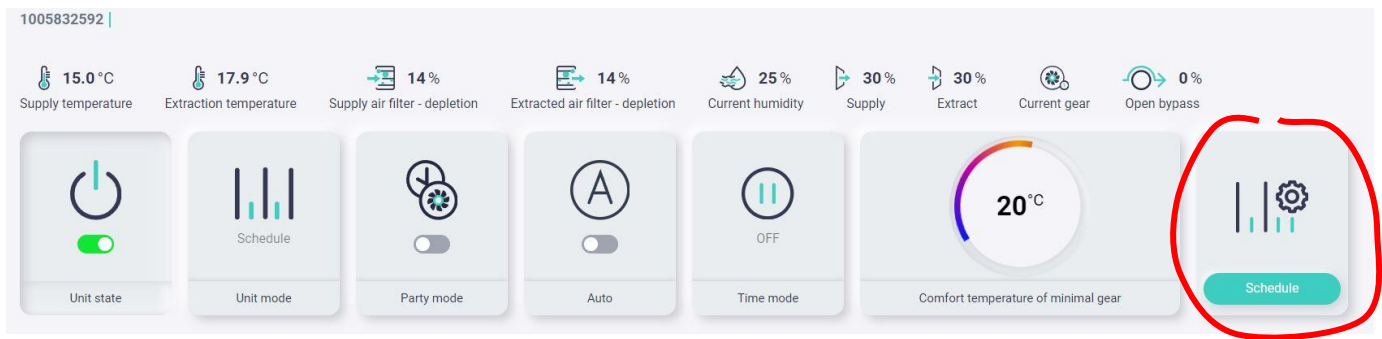

Clicking this button will bring up the weekly programme creation window. This allows to set up a weekly schedule for your device according to your needs. Once you have set up each day's schedule, click the "Accept" button at the bottom of the window".

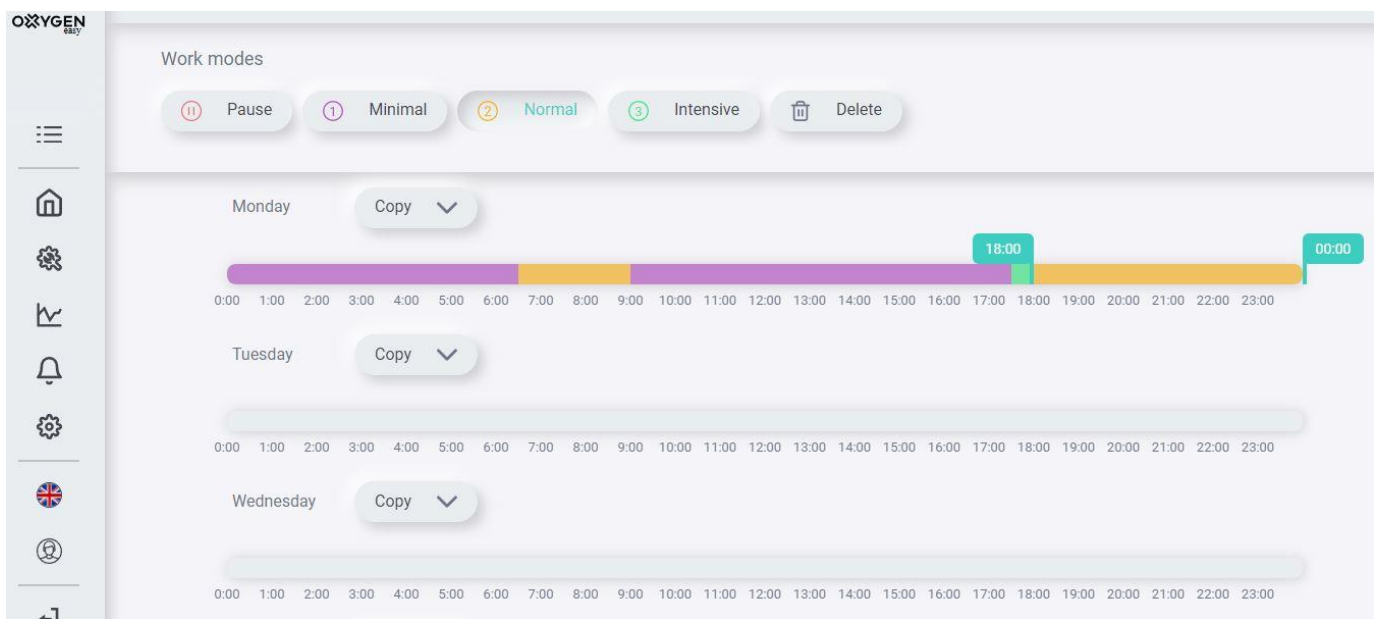

**Unit state** – selection of fan speeds

**Party mode** – the device will operate in boost mode for the selected period of time. The function is useful for large gatherings.

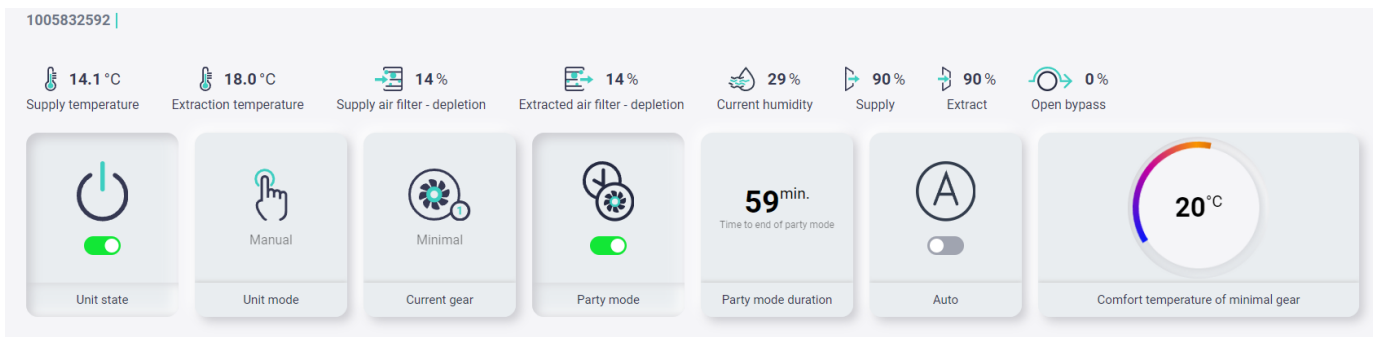

**Auto** – the unit will act on information from an external CO2 sensor (if fitted and activated).

**Comfort temperature of current gear** – This function only works in summer when the outside temperature is lower than the inside temperature, i.e. to cool the room.

### 5.4.2. “Devices parameters” window

**Web gateway** the window allows you to set the brightness of the illumination of the buttons on the remote Easy, the sound of the buttons and the sound of the error indication.

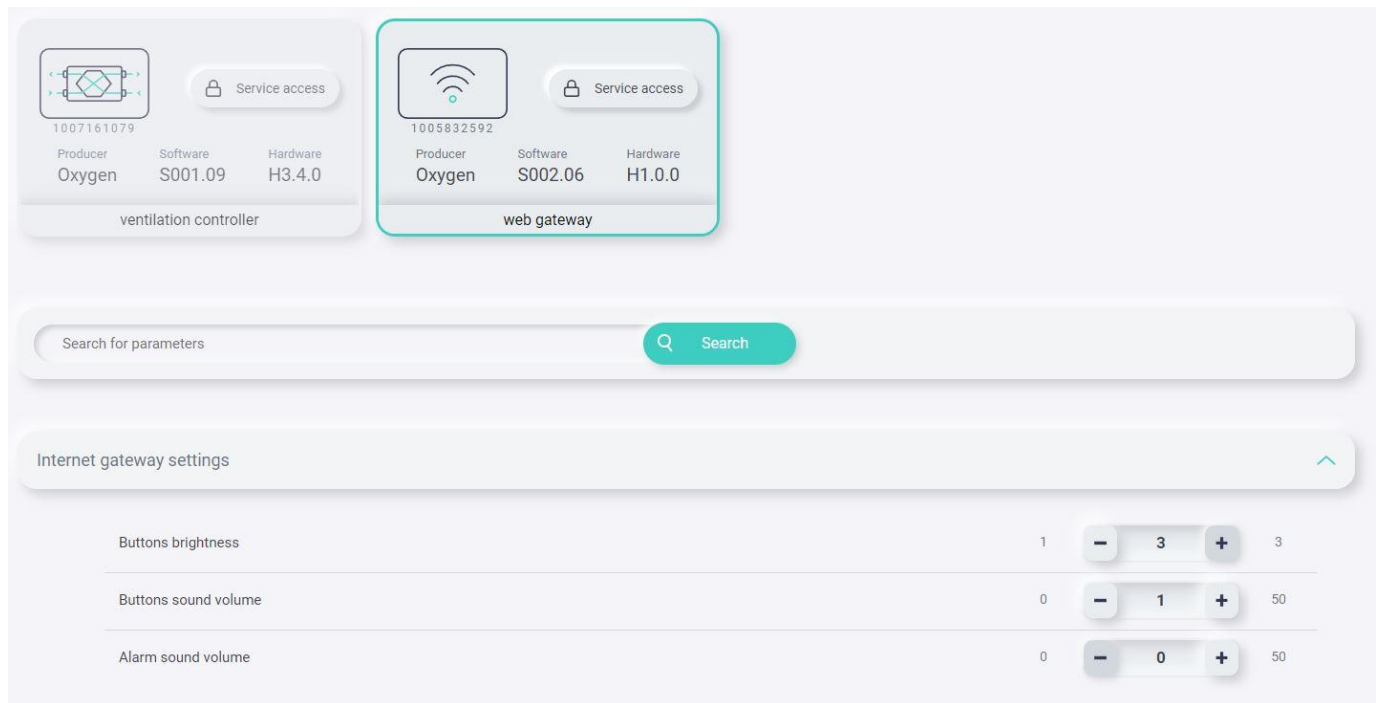

**Ventilation controller** the user menu list that appears in the Controller window allows you to view detailed information about the device and to perform important configuration steps. A detailed description of the user menu

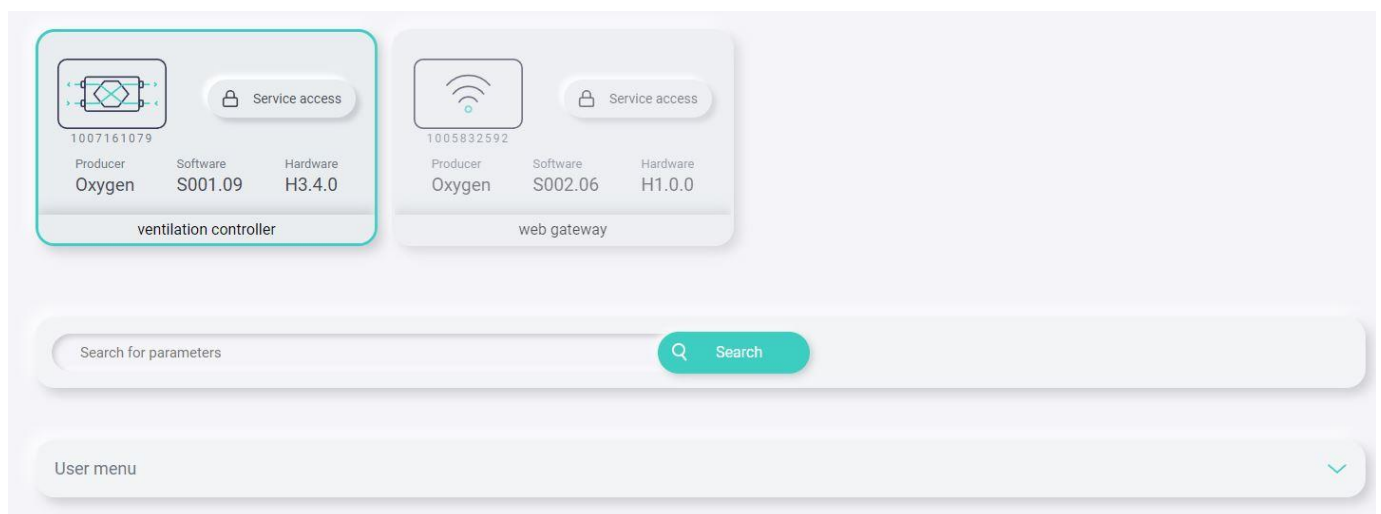

is given in table 5.